



Design of E Shaped Slotted Rectangular Microstrip Patch Antenna for Wireless LAN

Abha Soni*, Poonam Sinha* and Hemant Kumar Gupta**

*Department of Electronics and Communication, BUIT Bhopal, (MP) India

**Department of Electronics, Bethesda Institute of Technology Science Gwalior, (MP) India

(Corresponding author Abha Soni)

(Received 05 February, 2014 Accepted 7 April, 2014)

ABSTRACT: Today life cannot be imagined without wireless communication. In this paper two antenna for wireless LAN has been designed. First antenna is Rectangular Microstrip Patch Antenna(RMPA) and Second one is E-Shaped Slotted Rectangular Microstrip Patch Antenna(ESSRMPA). Basic property of both the antenna like simulated design, Returnloss, directivity, Radiation Pattern bandwidth are discussed. Finally it is shown that Return Loss of an Antenna in Slotted Patch is decreased about 32.79%, and Total Efficiency of slotted RMPA is highly increased about 83.07%,bandwidth of the slotted antenna is also increased about 14.28%,Slotted Rectangular Microstrip Patch Antenna also Reduces the size of antenna which is always a basic need of Patch antenna design system.

Keywords: Rectangular Microstrip Patch Antenna (RMPA), E-Shaped Slotted Rectangular Microstrip Patch Antenna (ESSRMPA), return loss, directivity.

I. INTRODUCTION

Microstrip Patch Antennas are always famous due to their easy fabrication, small size, and low cost, light weight in cellular mobile phone industry. Mobile phone system need a small size antenna which can easily be fit inside the body of cellular phone, although continuous attempts have resulted in increased Gain, bandwidth, and directivity. A truncated RMPA is designed to improve the performance of RMPA for GSM application in this paper [1].

A new design is shown of a compact, lightweight, low-cost, multistandard antenna for GSM/PCS/UMTS cellular telephone system and Hiprelan applications. Measured and simulated results of the resonant frequency, return loss, radiation patterns and SAR distribution are presented. Simulation analysis was performed using the HFSS software. A prototype of this antenna was fabricated; the good agreement with the simulation provides validation of the design procedure [2].

Newly designed CMPA with 2slit slot, 3slit-slot, and 6slit-slot and observed results for different designs, and finally it is shown that as slit-slot increases to six slit-slot Return-loss and Bandwidth of CMPA are reduced. The multiband antenna can be used for wireless communication in different applications. Bandwidth improvement is about 63.3%, 72.10% and 37.5% respectively in two, three and six slit-slotted patch when compared to their basic design bandwidth band. Antenna is changed to multiband by slit-slot Circular Microstrip Patch Antenna (CMPA) [3].

The purpose of this paper is to design a Different microstrip patch antenna with Defect Ground Structure (DGS) for efficient rectenna design.

This antenna having the property of high harmonics rejection at unwanted frequencies at 2.0131GHz, and 2.457GHz, 2.565GHz as the designed frequency is 1.3 GHz and return loss is decreased about 43.17%by the DGS structure. It is also used to remove the harmonics and reduce the size of antenna [4].

In this paper very low losses RMPA for mobile communication is designed and two designs of Patch antenna has been Compared and observed after introducing slot into the simple RMPA .All the basic property of antenna has been improved [5], all paper shows the effects of SAR distribution with mobile communication and gives the ideal value of SAR distribution with not effecting the human health from mobile communication [6-9].

II. ANTENNA DESIGNS

In this section antenna is designed using a CST-Microwave Studio simulation software and displays the parameter by the figures.

First of all there is a need to select a dielectric constant and substrate height to design an antenna as these are basics to design an antenna, these are chosen according to the design frequency and our designed frequency band is 2.4Ghz .The chosen material is Rogers lossy R03206.

1. Substrate Height =1.6mm
2. Dielectric Constant=6.15
3. Loss Tangent=.0027

Both antenna RMPA and ESSRMPA (E-Shaped Slotted RMPA) has been designed in this section and the results are shown by Graph or figure. The Length and Width of Microstrip Patch Antenna has been calculated by the formula given in References books [10].

All other parameters like cut width, cut depth, continue straight path length and width are calculated by iteration on simulation software and dimensions are stored for best simulation results. Antenna Designed by simulation Software, its return loss graph, Directivity Graph, Electric field Distribution, Radiation pattern all Graph are Given below for both the antenna designs RMPA and ESSRMPA by CST-MWS simulation Software [11].

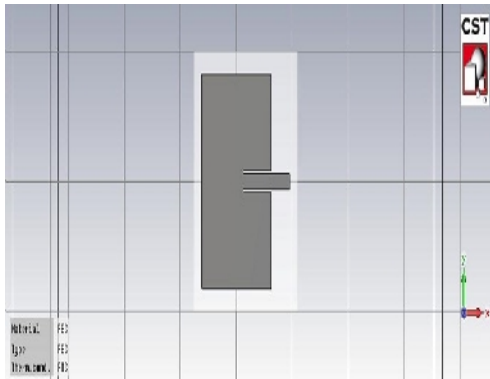

Fig. 1. Simple RMPA for wireless LAN.

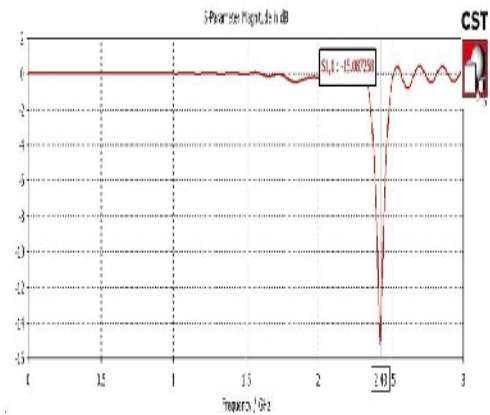

Fig. 2. Simulated Return Loss vs. Frequency of Simple RMPA is 15.08dB.

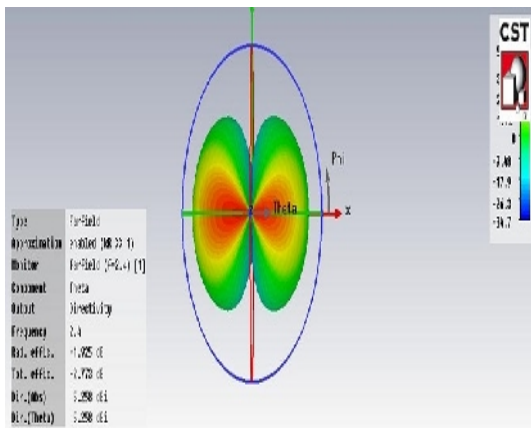

Fig. 3. Radiation Pattern of Simple RMPA is 5.258dBi.

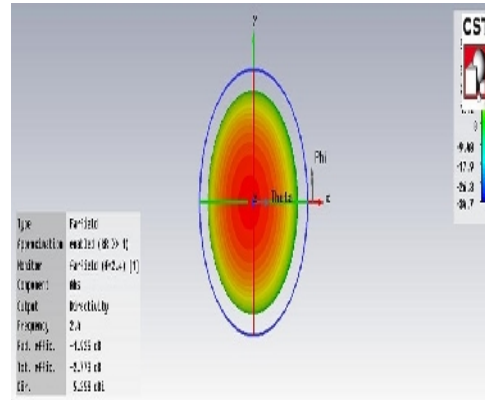

Fig. 4. Total Efficiency of Simple RMPA is 2.773dB.

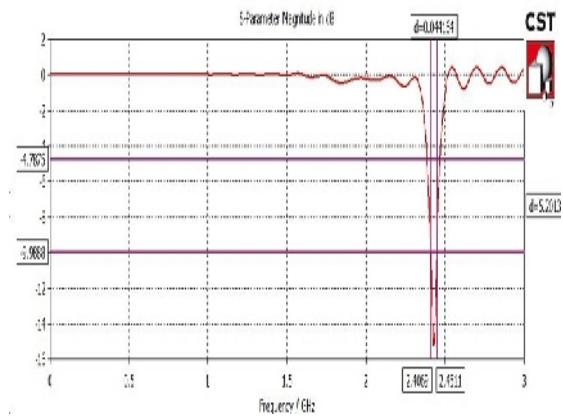

Fig. 5. Bandwidth of Simple RMPA 44.16MHz.

Table 1. Parameter of Simple Rmpa for wireless lan.

Frequency (GHz)	Return loss(dB)	Directivity (dBi)	Bandwidth(MHz)	Total Efficiency(dB)
2.43	15.08	5.258	44.16	2.773

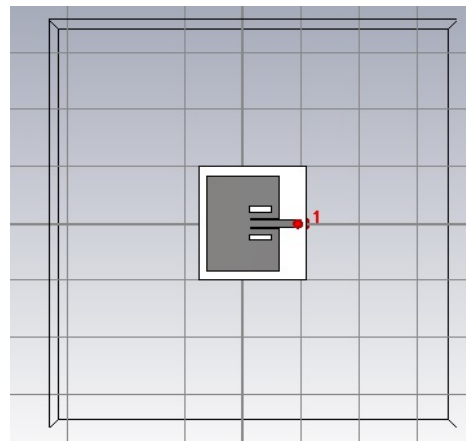

Fig. 6. E shaped Slotted RMPA for wireless LAN.

As it is very clear from the Fig. 1, Fig. 2, Fig. 3, Fig. 4, Fig. 5 and Table I that, antenna is working on the 2.43GHz and giving return loss 15.08dB, Directivity 5.258dbi and bandwidth of 44.16MHz which is very good enough for proper working of an antenna. Now E Shaped slot has been introduced into the simple microstrip patch as shown into the Fig. 6 having a dimension of (2*4mm²). Slot is lowering the losses and e increasing bandwidth and efficiency continuously, which is very important aspect to design this antenna system.

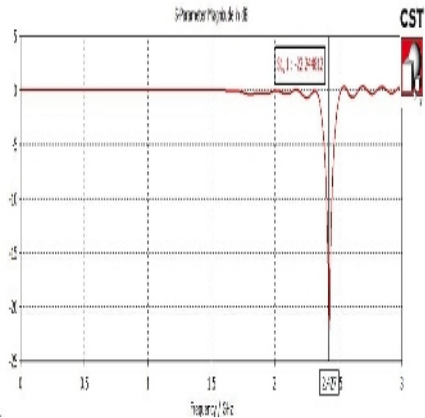

Fig. 7. Simulated Return-loss of E-Shaped Slotted RMPA is 22.242dB at 2.427GHz.

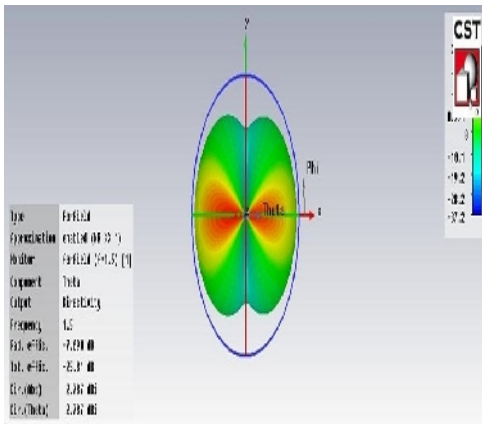

Fig. 8. Directivity of E-Shaped Slotted RMPA is 2.787 dBi.

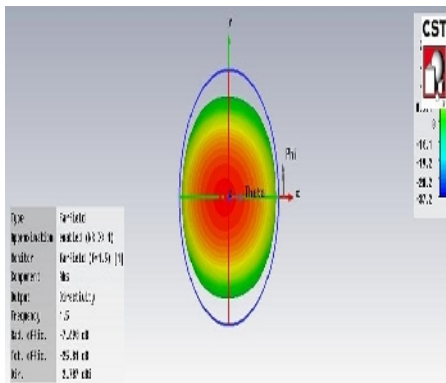

Fig. 9. Total efficiency of E Shaped Slotted RMPA is 25.81dB

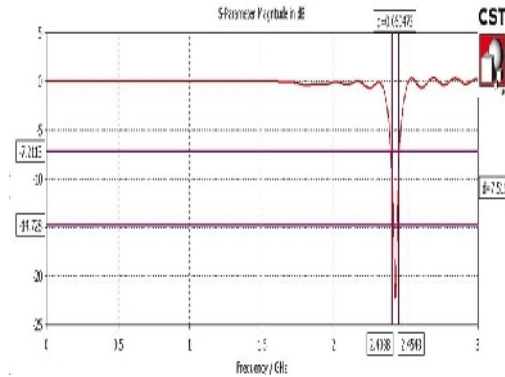

Fig. 10. Bandwidth of Slit-Slotted RMPA 50.473MHz. Table 2: Parameter of E Shaped -Slot Rmpa for wireless lan.

Frequency(G Hz)	Returnloss(dB)	Directivity(dBi)	Bandwidth(M Hz)	Total Efficiency(dB)
2.427	22.242	2.787	50.473	25.81

III. RESULT

Finally from the designed antenna shown in Fig. 6 as compared in Fig. 1, the size is reduced. It is very obvious from Fig. 2 and Fig. 7 that Return-loss of antenna get decreased about 47.48% ,antenna directivity is reduced as compared from simple patch antenna this is due to the highly improvement in total efficiency Fig. 3 and Fig. 8, antenna total efficiency is highly increased from 2.783dB to 25.81dB as very clear from figure 4 and 9, bandwidth of designed antenna is also improved from 44.16MHz to 50.73MHz as it is very clear from Fig. 5 and Fig. 10.

IV. CONCLUSION

Now it can be concluded from above figures and tables that Response of Antenna improved as it is slotted. Antenna size is reduced due to the E-Shaped slotted structure. Antenna efficiency and bandwidth is increased. Antenna Return-loss decreased and efficiency is increased and maximum output is achieved.

REFERENCES

[1]. John D. Kraus. *Antennas*. 2nd Edition.McGraw Hill International, 1988.
 [2]. M. Ben Ahemad, M. Bouhorma, F. Elouaai, A. mouni Design of New Multi Standard Patch Antenna GSM / PCS / UMTS /HIPERLAN for Mobile Cellular Phones in EJSR. *European Journal of Scientific Research*, Vol.32 No.2 2009 p.p 151-157.
 [3]. Hemant Kumar Gupta, P.K. Singhal, Pavan Kumar Sharma, Veernedra Singh Jadun “Slotted Circular Microstrip Patch Antenna Designs for multiband Application in Wireless Communication”in Science Publishing Coroperation *IJET open Access Journal* (U.A.E) Vol. No.3 Issue .1 pp 158-167 .

- [4]. Hemant Kumar Gupta, P.K. Singhal “ Patch Antennas Designs with Different Shaped Defect Ground Structure Pattern in Efficient Rectenna Design for Wireless Power Transmission” in *IJECCT open access journal (Malayisa)* Vol. **3** Issue No.1.
- [5]. Hemant Kumar Gupta, Bhupesh Gautam, Poonam Sinha, Abha Soni “Design of very low return losses Rectangular Microstrip Patch Antenna for Cellular and mobile Communication in *IJEEE USA* in Vol. **1** Issue No.3 pp 195-198.
- [6]. S. Khalatbari, D. Sardari, A. A.Mirzaee and H. A. Sadafi,, ”Calculating SAR in Two Models of the Human Head Exposed to Mobile Phones Radiations at 900 and 1800 MHz”, *Progress In Electromagnetic Research Symposium 2006, Cambridge, USA*, **2**, (1), March 26-29, pp.104-109.
- [7]. Study of EM Interaction between Human Head and Mobile Cellular Phone M. Bouhorma, A. Benahmed, F. Elouaai, A. Astito and A. Mamouni. Information and Communication Technologies International Symposium. Tetuan, Morocco 3-4-5-6 June 2005.
- [8]. Evaluation of the SAR distribution in the human head for cellular phones. M. Bouhorma, M. Benahmed, F. Elouaai, H. Drissi A. Mamouni. IWWCUCA June, 6th and 7th 2005 in Val-d'OrQuebec, Canada.
- [9]. D. Manteuffel, A. Bahr, D. Heberling, and I. Wolff, “Design considerations for integrated mobile phone antennas,” in *Proc. 11th Int. Conf. Antennas Propagat., Apr. 17–20, 2001, pp. 252–256*.
- [10]. C. Balinies, “Antenna Theory”, Wiley, 2nd addition chapter -14 ISBN 0-471-59268-4., (1997).
- [11]. <http://www.cst.com/content/products/mws/overview.aspx>
© 2012 CST Computer Simulation Technology